

Dynamical Analysis of Rotary Tiller(II) : Measurement of Stress on Chain Tightener

著者	Iwasaki Koichi, Miyabe Yoshiteru, Kashiwagi Sumitaka
journal or publication title	Memoirs of the Faculty of Agriculture, Kagoshima University
volume	30
page range	121-127
URL	http://hdl.handle.net/10232/2874

Dynamical Analysis of Rotary Tiller (II)

—Measurement of Stress on Chain Tightener—

Koichi IWASAKI, Yoshiteru MIYABE and Sumitaka KASHIWAGI

(*Laboratory of Agricultural Systems Engineering*)

Received for Publication September 10, 1993

Introduction

In order to reduce the noises and the vibrations caused by the clutching of the chain and the sprocket, a chain tightener is generally used. A tightener is one of the small parts of a rotary tiller, for it generally a commonly vended flat bar is used, but if it should be broken down, the performance of tilling work comes to be impossible. Owing to the fact that repeated load acts inevitably on the tightener in the process of tillage work, the fatigue strength of the material should be considered in the stage of designing the chain tightener system leading to the whole structure of transmission system of a rotary tiller.

As to the establishment of the designing theory for the sprocket, chain and tightener system, some geometrical analyses of chain and sprocket motion were reported in the previous paper¹⁾.

In this paper, the stress on tightener under various tilling conditions were measured. Making use of the measured results, evaluation of the tested tightener was discussed from the view point of the fatigue strength.

Experimental Apparatus and Methods

The tractor and the rotary tiller used in the experiments were similar to those reported in the previous paper¹⁾. The material of the tested tightener is SK5P, which is an elastically enforced material. For the measurement of the stress acting on a tightener, a strain gauge was attached at the center of the tightener. The sketched shape, and the location of the attached strain gauge are shown in Fig.1.

Various tillage conditions are thought to be affecting the stress of the tightener, and so the depth of tillage and the tilling pitch were selected as the important factors. The depth of tillage was made to be varied from 6 to 12cm by changing the gauge-wheels of the rotary tiller. The tilling pitch was made to be varied from 23.7 to 48.0cm by changing the forward speed of the tractor. As the soil condition is also another important factor for tillage system, the tested field was prepared as follows. The tested field was tilled sufficiently with rotary tiller and afterwards the tractor was made to drive on the tilled soil repeatedly to compact them with its tire lug. The hardness of the soil measured by the SR-2 type soil hardness tester is shown in Fig.2. The moisture content of the soil was 24.2% (d.b.) on the average. The tillage conditions are shown in Table 1.

The tightener was installed in a chain case and the rotary tiller was positioned at a certain height by adjusting the gauge-wheels. The engine speed was kept 1800rpm, which causes the rotary shaft to be rotating at 155rpm. The tractor moved forward in a certain speed performing tillage

work, while the passing time of 3m was measured to calculate the moving speed. Under such conditions, the tightener was repeatedly tightened and loosened by the influence of the tillage resistance acting upon a rotary shaft. The stress data were amplified and recorded on Memory Hi Corder (HIOKI) mounted on the tractor as shown in Fig.3.

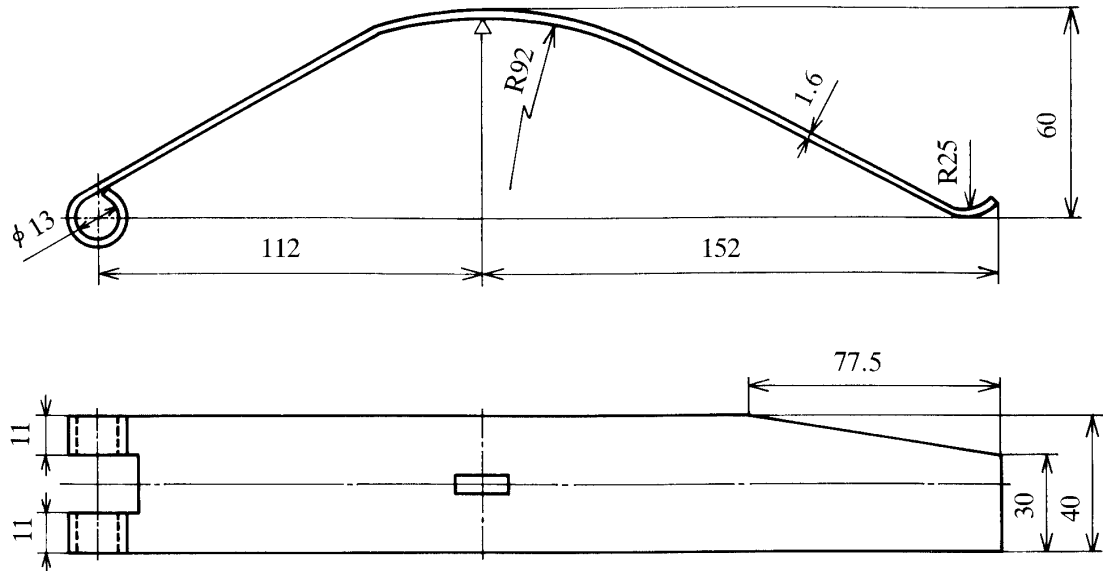

Fig. 1. Sketched shape of the tested tightener and location of attached gauge.

Table 1 Tillage conditions at the measurement

Engine speed (rpm)	1800			
Depth of tillage (cm)	6.0	9.0	12.0	
Tractor speed (km/h)	2.22	3.18	4.32	5.90
Rotational speed of rotary shaft (rpm)	150			
Tilling pitch (cm)	24.7	35.3	48.0	65.5

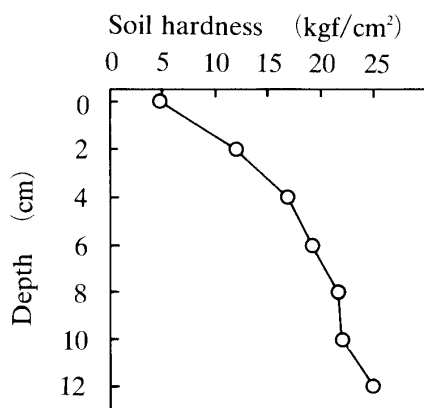

Fig. 2. Soil hardness of the tested field.



Fig. 3. Measurement with tractor and rotary tiller.

Results and Discussion

1. Depth of tillage

The measured mean stress and the amplitude of the stress at various depths of tillage are shown in Fig.4 (a), (b). As the depth of tillage increased from 6 to 12cm, the mean stress decreased gradually in every tilling pitch. Concretely, the mean stress decreased from around 61.3 to 58.4kgf/mm², which means the mean stress became lowered around 5% with the increase of the depth of tillage. On the other hand, the amplitude of the mean stress increased with the increase of the depth of tillage on the average. Concretely, the amplitude of the stress increased from around 7.2 to 8.3kgf/mm², which means the amplitude of the stress got raised around 15% with the increase of the depth of tillage.

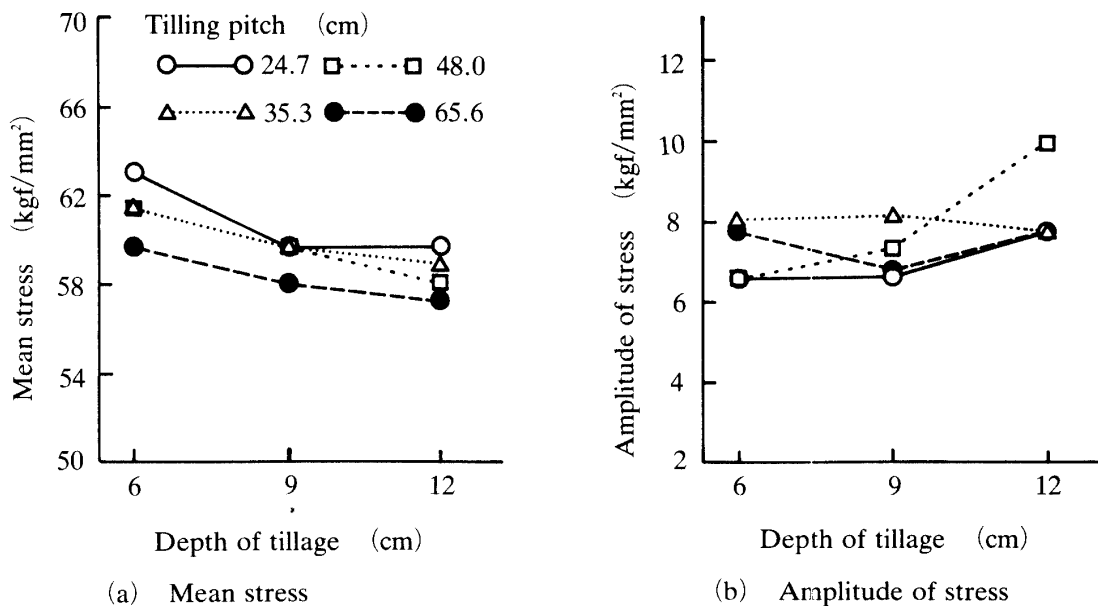

Fig. 4. Influence of depth of tillage.

2. Tilling pitch

The measured mean stress and the amplitude of the stress at the various tilling pitches are shown in Fig.5 (a), (b). As the tilling pitch increased from 24.7 to 65.6cm, the mean stress decreased gradually in every depth of tillage. Concretely, the mean stress decreased from around 60.8 to 58.3kgf/mm², which means the mean stress became lowered around 4% with the increase of the tilling pitch. The amplitudes of the stress showed no obvious trend, but they increased with the increase of the tilling pitch on the average. Concretely, the amplitude of the stress increased from around 7.0 to 7.4kgf/mm², which means that the amplitude of the stress got raised around 6% with the increase of the tilling pitch.

These trends described in 1. and 2. are considered to be caused by the reason mentioned below. Both increase of the depth of tillage and that of the tilling pitch caused the increase of the tillage resistance, and the chain on the opposite side of the tightener seemed to become tensed. Consequently, the chain on the tightener side was loosened; and this resulted in the decreasing of the mean stress of the tightener. While with the increase of the tillage resistance, the rotary shaft came to be suffered from the impact force, and so the amplitude of the stress increased.

3. Inclination of the chain case

When the rotary tillage is performed the tractor should turn at the end of the field, and at that time the rotary tiller is lifted up and the chain case comes to be inclined. To investigate the influence of the

inclination of the chain case upon the mean stress and the amplitude of the stress of the tightener, the chain case was made to be inclined from 70 to 86deg, and the stress was measured.

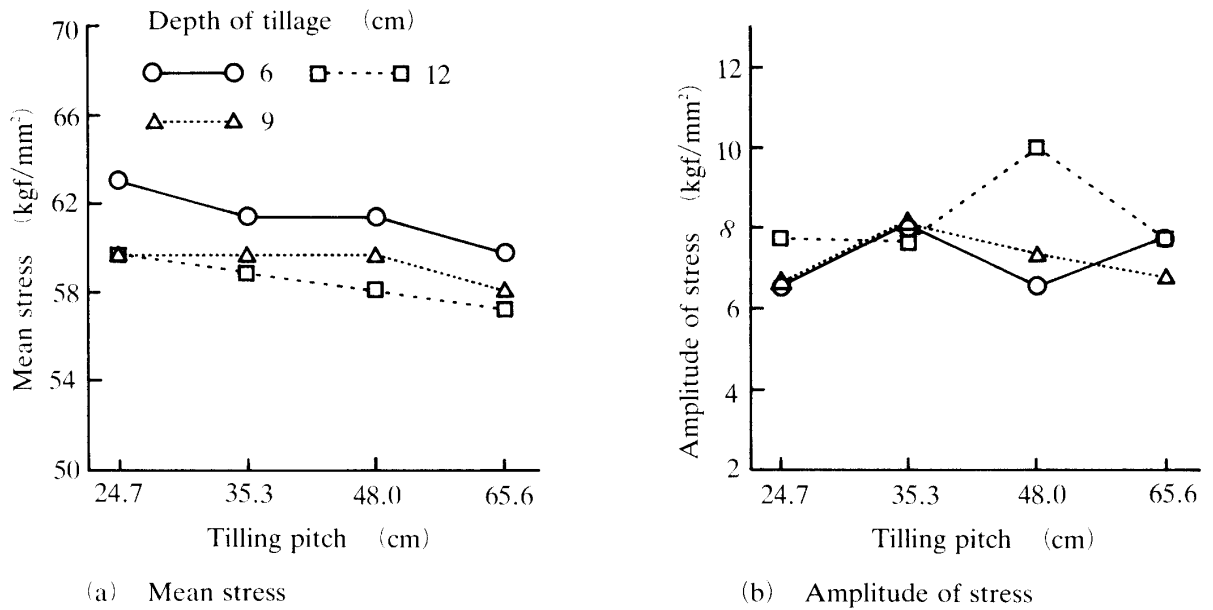

Fig. 5. Influence of tilling pitch.

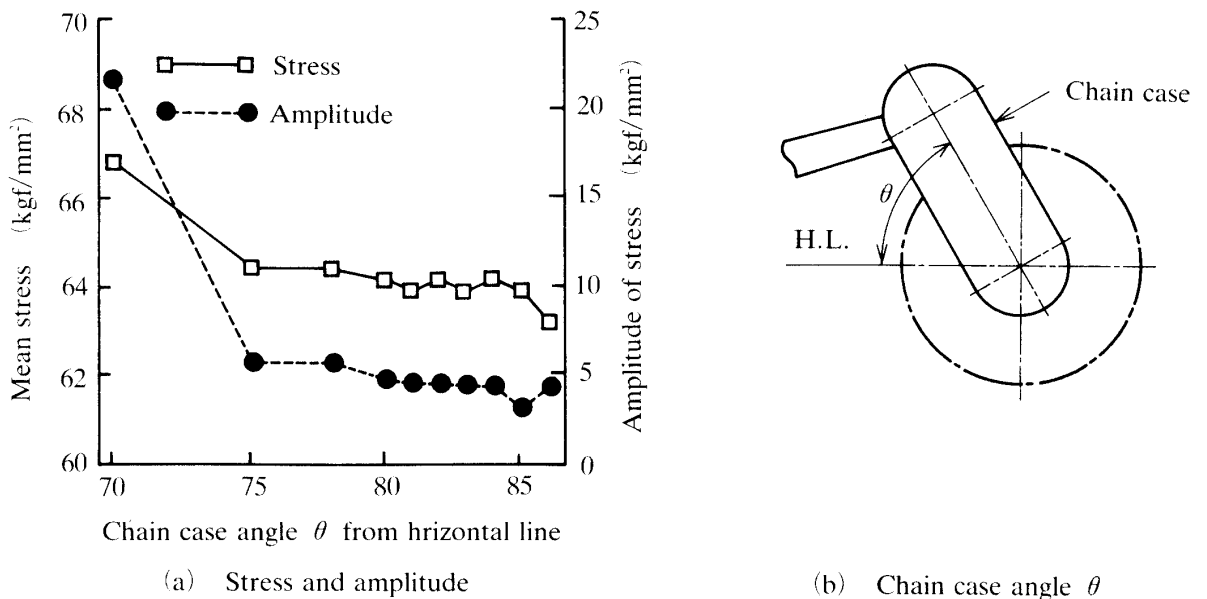

Fig. 6. Influence of the inclination of the chain case.

The measured mean stress and the amplitude of the stress are shown in Fig.6(a). The inclined angle means the angle between the center line of the chain case and the horizontal line (Fig.6(b)). When the inclined angle was small, the mean stress and the amplitude of the stress showed remarkably large value; and as the inclined angle increased, the mean stress and the amplitude of the stress abruptly decreased to nearly constant value. Concretely, as the inclined angle increased from 70 to 86deg, the mean stress came to be decreased from 66.8 to 64.1kgf/mm², which means that the mean stress became lowered around 4%. As for the amplitude of the stress, it decreased from 21.6 to 4.7kgf/mm², which means that

the amplitude of the stress came to be lowered around 78%.

The reason of these phenomena is considered to be as follows. When the chain case is inclined, the weight of the chain affected on the tightener and the mean stress of the tightener increased. As the influences of the clutching of the chain and the sprocket and of the chain link plate on the tightener, increased with the increase of the inclination of the chain case, the amplitude of the stress showed a larger value. These results indicate the fact that for the chain tightener a serious condition is brought about occurs when the chain case inclined so much, as the rotary tiller came to be lifted up at the each end of the field.

4. Reverse torque test

Some of the rotary tillers are equipped reverse rotation mechanism, and in that case an additional tightener is usually to be installed symmetrically. To ascertain the influence of reverse rotation upon the tightener, reverse torque test was carried out. At the measurement, as shown in Fig.7, a flat bar was attached instead of a rotary blade, and at the end of the flat bar a certain amount of weight was loaded and the stress at a certain torque was recorded.

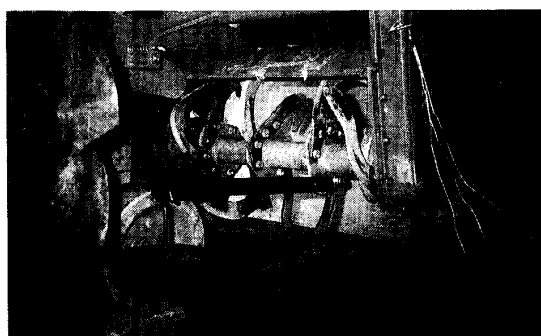

Fig. 7. Measurement of stress at reverse torque.

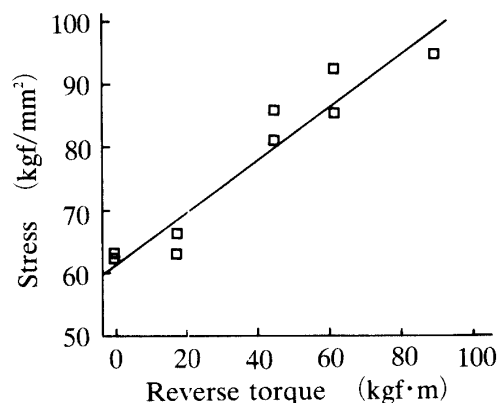

Fig. 8. Stress at reverse torque.

Measured stress at various torque are shown in Fig.8. As shown in this figure, as the torque increased the stress increased linearly. With the results of linear regression, the stress increased from 61.6 to 99.2kgf/mm², as the reverse torque increased from 0 to 90kgf · m.

This result suggests that the tightener suffers very serious conditons if the rotary tiller is equipped with reverse rotation mechanism.

5. The fatigue strength of the tested tightener

To discuss the fatigue strength of the material, the fatigue limit diagram should be drown up in advance to the Goodman's equation,

$$\sigma_a / \sigma_w + \sigma_m / \sigma_s = 1$$

where, σ_a : amplitude of stress,

σ_w : tensile strength,

σ_m : mean stress,

σ_s : completely reversed fatigue limit.

The material of the tightener is SK5P whose completely reversed fatigue limit σ_s is 204 to 296kgf/mm², and the tensile strength σ_w can be calculated, multiplying σ_s by 0.35. The obtained fatigue limit diagram of the tested material is shown in Fig.9. The hatched area shows the safety zone for the material. The measured mean stress and the amplitude of the stress are indicated in that diagram at the tillage test and the chain case inclination test. After comparing the size of the measured stress and the safety zone of the material, the tightener is considered to have an adequate quality in its strength.

The test conditions in this paper were not so hard, but if tillage work should be continued for a long

The test conditions in this paper were not so hard, but if tillage work should be continued for a long time, the load may cause elongation of the chain and it may affect on the looseness of the chain. So further research, regarding the influence of the time effects or the resistance against the tough soil and the tilling conditions, is expected.

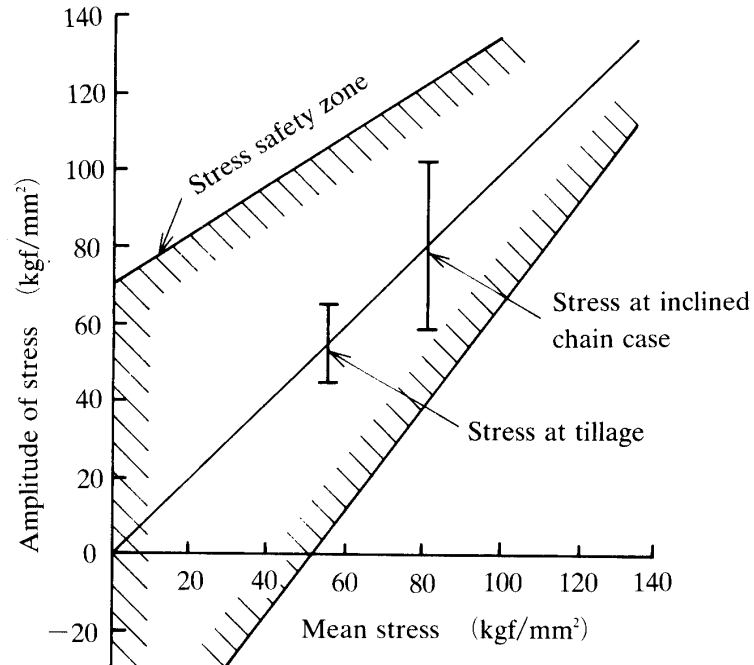

Fig. 9. Measured stress and fatigue limit diagram of SK5P.

Summary

To clarify the influence of various situations of the tillage in the field on the chain tightener system, the stress of the chain tightener was measured, and with the measured results the fatigue strength of the tested tightener was discussed.

The obtained results are as follows.

(1) As the depth of tillage increased from 6 to 12cm, the mean stress decreased gradually from 61.3 to 58.4kgf/mm², while the amplitude of the stress increased from 7.2 to 8.3kgf/mm².

(2) As the tilling pitch increased from 24.7 to 65.6cm, the mean stress decreased gradually from 60.8 to 58.3kgf/mm², the amplitude of the stress increased from 7.0 to 7.4kgf/mm².

The results (1) and (2) were considered to be caused by the increase of tillage resistance leading the looseness of the chain on the tightener side.

(3) The mean stress and the amplitude of the stress showed remarkably large value when the inclined angle of the chain case from the horizontal line was small, and as the angle increased, they abruptly decreased to nearly constant value.

(4) As ascertained by the reverse torque test, the stress of the tightener increased from 61.6 to 99.2kgf/mm² as the reverse torque increased from 0 to 90kgf · m. This result indicates that the tightener suffers serious defect due to the reverse rotation of a rotary tiller.

(5) Judging from the measured stress of the tightener and the safety zone of the material SK5P, the tightener was considered to be in possession of an adequate quality seen from the view point of the fatigue strength.

References

- 1) Iwasaki, K., Miyabe, Y. and Kashiwagi, S.: Dynamical Analysis of Rotary Tiller— Measurement of Stress on Chain Tightener—. *Mem. Fac. Agr. Kagoshima Univ.*, 29,93-99 (1993)